

3. INPUT VOLTAGE

Input voltage	nom.	DC 24V	
Input voltage range		14.4-32.4Vdc	full specified
	max.	36.0Vdc	absolute maximum continuous input voltage with no damage to the DC/DC converter
Allowed voltage between input and earth	max.	60Vdc or 42.2Vac	in case the output voltage is not grounded.
Allowed input ripple voltage	max.	5Vpp	47Hz-40kHz, the momentary input voltage must always be within the specified limits.
Turn-on voltage	typ.	17.5Vdc	steady-state value, see Fig. 3-1
Shut-down voltage	typ.	14.0Vdc	steady-state value, see Fig. 3-1
	typ.	35.0Vdc	steady-state value, see Fig. 3-1
Input current	typ.	4.25A	at 24Vdc input and output 24V, 3.8A, see Fig. 5 4
Start-up delay	typ.	290ms	see Fig. 5 3
Rise time	typ.	520ms	0mF, 24V, resistive load 3.8A, see Fig. 5 3
	typ.	610ms	3.8mF, 24V, resistive load 3.8A, see Fig. 5 3
Turn-on overshoot	max.	500mV	see Fig. 5 3
Input capacitance	typ.	3 000µF	external capacitors on the input voltage bus are allowed without any limitations.

Fig. 3-1 **Input voltage range**

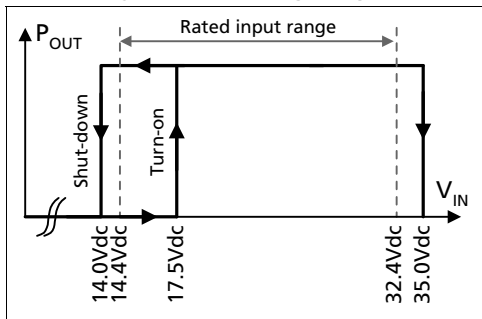

Fig. 3-2 **Turn-on behavior, definitions**

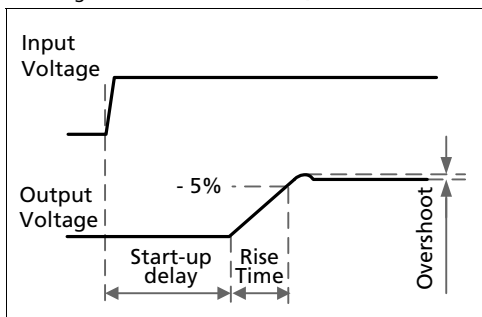
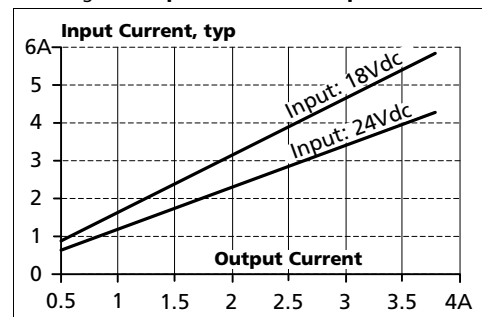

Fig. 3-3 **Input current vs. output load**



4. SOFT-START AND INPUT INRUSH CURRENT SURGE

Inrush current limitation

An active inrush limitation circuit (inrush limiting resistor which is bypassed by a relay contact) limits the input inrush current after turn-on of the input voltage.

The charging current into EMI suppression capacitors is disregarded in the first microseconds after switch-on.

Inrush current	max.	1.6A _{peak}	-25°C to +70°C, input: 24Vdc
	typ.	1.2A _{peak}	-25°C to +70°C, input: 24Vdc
Inrush energy	typ.	negligible	-25°C to +70°C, input: 24Vdc

Fig. 4-1 Input inrush current, typical behavior

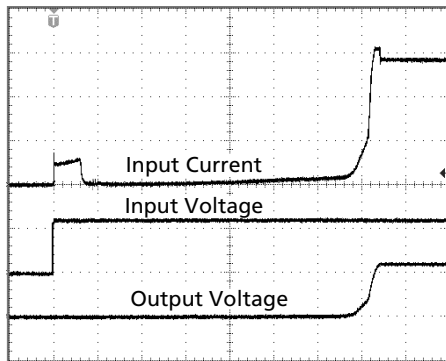

Input: 24Vdc
 Output: 24V, 3.8A, constant current load
 Ambient: 25°C

Upper curve: Input current 2A / DIV
 Middle curve: Input voltage 20V / DIV
 Lower curve: Output voltage 20V / DIV
 Time basis: 100ms / DIV

Soft-start function:

After the DC/DC converter is turned on, the internal output current rises slowly to its nominal value. This method charges the output capacitors (internal and external capacitors) slowly and avoids high input currents during turn-on. High input currents can produce a high voltage drop on the input wiring (especially with long and thin cables) which reduces the terminal voltage on the DC/DC converter. If the terminal voltage is below the shut-down voltage, the DC/DC converter will turn-off and will make a new start-up attempt. This effect is avoided with the integrated soft-start function. Please note, that this function increases the rise time of the output voltage by a small amount.

Fig. 4-2 Soft-start behavior

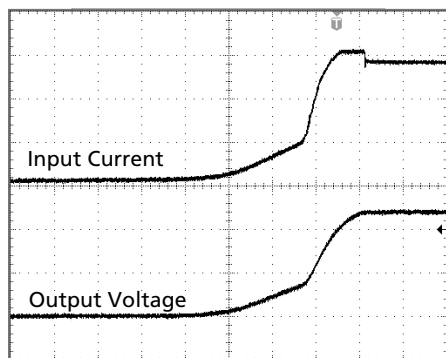

Input: 24Vdc
 Output: 24V, 3.8A, constant current load
 Ambient: 25°C
 No additional external output capacitors

Upper curve: Input current 2A / DIV
 Lower curve: Output voltage 10V / DIV
 Time basis: 20ms / DIV

5. OUTPUT

Output voltage	nom.	24V	
Adjustment range	min.	-	not adjustable
Factory setting		24.1V	±0.2%, at full load, cold unit
Line regulation	max.	25mV	Input voltage variations between 18 to 32.4Vdc
Load regulation	max.	100mV	static value, 0A → 3.8A
Ripple and noise voltage	max.	50mVpp	20Hz to 20MHz, 50Ohm
Output current	nom.	3.8A	see Fig. 5-1
Output power	nom.	92W	
Short-circuit current	min.	3A	continuous current, short circuit impedance 200mOhm
	max.	6A	continuous current, short circuit impedance 200mOhm
Output capacitance	typ.	2 200µF	

Fig. 5-1 Output voltage vs. output current, typ.

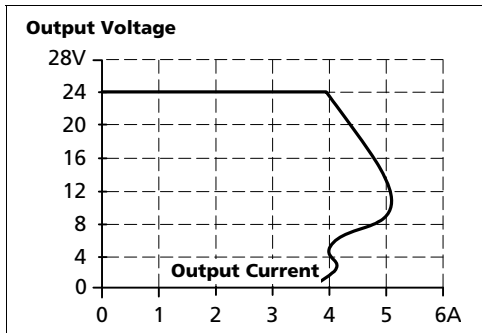
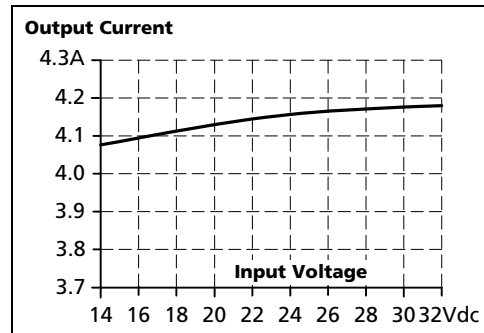

Fig. 5-2 Current limitation vs. input voltage, (23V constant voltage load), typ.



Peak current capability (up to several milliseconds)

The DC/DC converter can deliver a peak current, which is higher than the specified short term current. This helps to start current demanding loads or to safely operate subsequent circuit breakers.

The extra current is supplied by the output capacitors inside the DC/DC converter. During this event, the capacitors will be discharged and causes a voltage dip on the output. Detailed curves can be found in chapter 22.1.

Peak current voltage dips	typ.	from 24V to 16V	at 7.6A for 50ms, resistive load
	typ.	from 24V to 12.5V	at 15.2A for 2ms, resistive load
	typ.	from 24V to 8.5V	at 15.2A for 5ms, resistive load

6. HOLD-UP TIME

The input side of the DC/DC converter is equipped with a bulk capacitor which keeps the output voltage alive for a certain period of time when the input voltage dips or is removed. The bulk capacitor can be discharged by loading the DC/DC converter on the output side or through a load which is parallel to the input. There is no protection in the DC/DC converter which prevents current from flowing back to the input terminals. If prevention is needed, an external diode should be used.

Hold-up Time	typ.	13.8ms	input 24Vdc, output: 24Vdc, 1.9A, see Fig. 6-1
	typ.	7ms	input 24Vdc, output: 24Vdc, 3.8A, see Fig. 6-1

Fig. 6-1 Hold-up time vs. input voltage

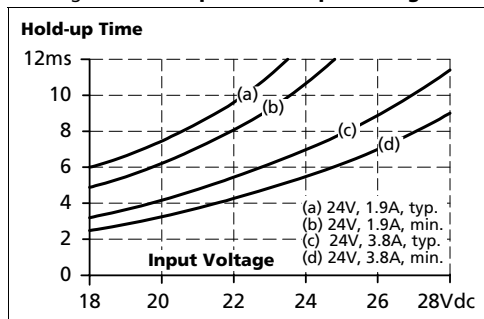

Fig. 6-2 Shut-down test setup

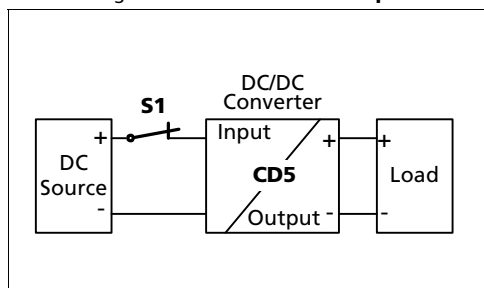
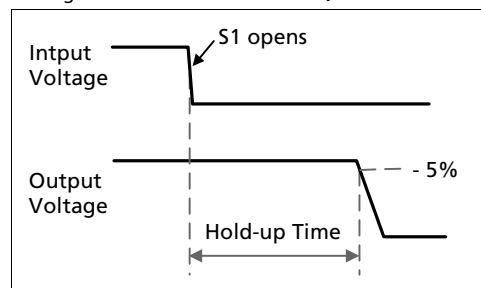

Fig. 6-3 Shut-down behavior, definitions



Note: At no load, the hold-up time can be up to several seconds. The green DC-ok lamp is also on during this time.

7. EFFICIENCY AND POWER LOSSES

Input 24Vdc

Efficiency	typ.	90.5%	at 24V, 3.8A
Power losses	typ.	0.7W	at no output load
	typ.	5.5W	at 24V, 1.9A
	typ.	9.7W	at 24V, 3.8A

Fig. 7-1 Efficiency vs. output current at 24V, typ.

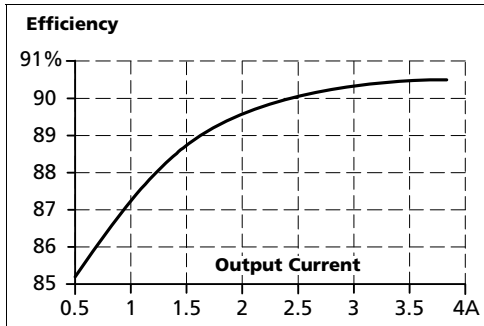

Fig. 7-2 Losses vs. output current at 24V, typ.

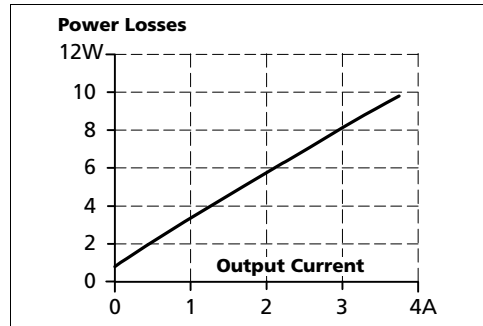

Fig. 7-3 Efficiency vs. input voltage at 24V, 3.8A, typ.

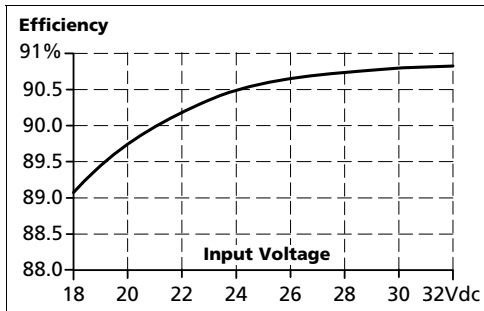
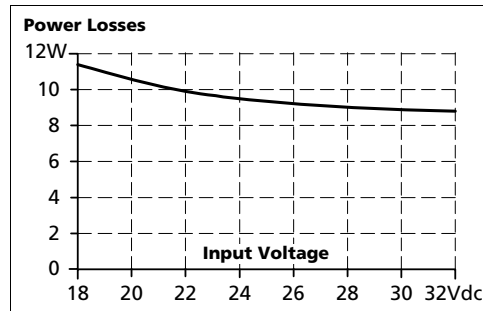

Fig. 7-4 Losses vs. input voltage at 24V, 3.8A, typ.



10. TERMINALS AND WIRING

	Input	Output
Type	spring-clamp terminals	spring-clamp terminals
Solid wire	0.5-6mm ²	0.5-6mm ²
Stranded wire	0.5-4mm ²	0.5-4mm ²
American Wire Gauge	20-10 AWG	20-10 AWG
Wire stripping length	10mm / 0.4inch	10mm / 0.4inch

Instructions:

- a) Use appropriate copper cables that are designed for an operating temperature of:
 60°C for ambient up to 45°C and
 75°C for ambient up to 60°C minimum
 90°C for ambient up to 70°C minimum.
- b) Follow national installation codes and installation regulations!
- c) Ensure that all strands of a stranded wire enter the terminal connection!
- d) Up to two stranded wires with the same cross section are permitted in one connection point.
- e) Screws of unused terminal compartments should be securely tightened.
- f) Ferrules are allowed, but not required

11. RELIABILITY

	Input 24Vdc	
Lifetime expectancy *)	228 000h	at 24V, 1.9A and 40°C
	134 000h	at 24V, 3.8A and 40°C
	378 000h	at 24V, 3.8A and 25°C
MTBF **) SN 29500, IEC 61709	1 487 000h	at 24V, 3.8A and 40°C
	2 534 000h	at 24V, 3.8A and 25°C
MTBF **) MIL HDBK 217F	665 000h	at 24V, 3.8A and 40°C; Ground Benign GB40
	937 000h	at 24V, 3.8A and 25°C; Ground Benign GB25

*) The **Lifetime expectancy** shown in the table indicates the minimum operating hours (service life) and is determined by the lifetime expectancy of the built-in electrolytic capacitors. Lifetime expectancy is specified in operational hours and is calculated according to the capacitor's manufacturer specification. The prediction model allows only a calculation of up to 15 years from date of shipment.

) **MTBF stands for **Mean Time Between Failure**, which is calculated according to statistical device failures, and indicates reliability of a device. It is the statistical representation of the likelihood of a unit to fail and does not necessarily represent the life of a product.

12. EMC

The DC/DC converter is suitable for applications in industrial environment as well as in residential, commercial and light industry environment without any restrictions. The CE mark indicates conformance with EMC guideline 89/336/EEC, 93/68/EEC and 2004/108/EC and the low-voltage directive (LVD) 73/23/EWG and 2006/95/EC. A detailed EMC report is available on request.

EMC Immunity	Generic standards: EN 61000-6-1 and EN 61000-6-2			
Electrostatic discharge	EN 61000-4-2	Contact discharge	8kV	Criterion A
		Air discharge	15kV	Criterion A
Electromagnetic RF field	EN 61000-4-3	80MHz-2.7GHz	10V/m	Criterion A
Fast transients (Burst)	EN 61000-4-4	Input lines	4kV	Criterion A
		Output lines	2kV	Criterion A
Surge voltage on input	EN 61000-4-5	+ → -	1kV	Criterion A
		+/- → chassis ground	2kV	Criterion A
Surge voltage on output	EN 61000-4-5	+ → -	500V	Criterion A
		+ / - → chassis ground	500V	Criterion A
Conducted disturbance	EN 61000-4-6	0.15-80MHz	10V	Criterion A

Criteria:

- A:** DC/DC converter shows normal operation behavior within the defined limits.
- C:** Temporary loss of function is possible. DC/DC converter may shut-down and restarts by itself. No damage or hazards for the DC/DC converter will occur.

EMC Emission	Generic standards: EN 61000-6-3 and EN 61000-6-4	
Conducted emission	IEC/CISPR 16-1-2, IEC/CISPR 16-2-1	Class B, input lines (Limits for DC power ports)
Radiated emission	EN 55011, EN 55022	Class B

This device complies with FCC Part 15 rules.

Operation is subjected to following two conditions: (1) this device may not cause harmful interference, and (2) this device must accept any interference received, including interference that may cause undesired operation.

Switching frequency

Variable between 90kHz and 135kHz depending on load and input voltage (output current > 0.5A)

13. ENVIRONMENT

Operational temperature *)	-25°C to +70°C (-13°F to 158°F)	see Fig. 13-1
Storage temperature	-40 to +85°C (-40°F to 185°F)	for storage and transportation
Humidity **)	5 to 95% r.H.	IEC 60068-2-30
Vibration sinusoidal	2-17.8Hz: ±1.6mm; 17.8-500Hz: 2g 2 hours / axis	IEC 60068-2-6
Shock	30g 6ms, 20g 11ms 3 bumps / direction, 18 bumps in total	IEC 60068-2-27
Altitude	0 to 6000m (0 to 20 000ft)	Reduce output power or ambient temperature above 2000m sea level.
Altitude de-rating	5.8W/1000m or 5°C/1000m	above 2000m (6500ft), see Fig. 13-2
Over-voltage category	III II	IEC 62103, EN 50178, altitudes up to 2000m Altitudes from 2000m to 6000m
Degree of pollution	2	IEC 62103, EN 50178, not conductive

*) Operational temperature is the same as the ambient temperature and is defined as the air temperature 2cm below the unit.

***) Do not energize while condensation is present

Fig. 13-1 **Output current vs. ambient temp.**

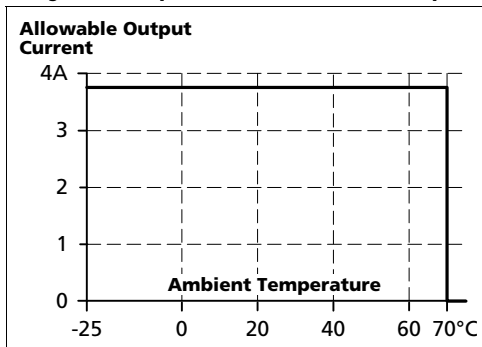
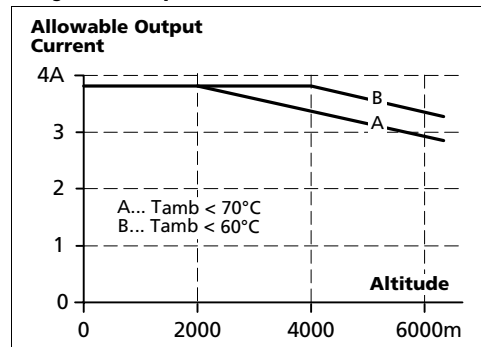

Fig. 13-2 **Output current vs. altitude at 24V**



14. PROTECTION FEATURES

Output protection	Electronically protected against overload, no-load and short-circuits *)	
Output over-voltage protection	typ. 31Vdc max. 32Vdc	in case of an internal power supply defect, a redundant circuit limits the maximum output voltage. The output shuts down and automatically attempts to restart.
Reverse input polarity protection	Included	unit does not start when input voltage is reversed
Output over-current protection	electronically limited *)	see Fig. 5-1
Degree of protection	IP 20	EN/IEC 60529
Penetration protection	> 3.5mm	e.g. screws, small parts
Over-temperature protection	yes	output shut-down with automatic restart
Input transient protection	MOV	Metal Oxide Varistor
Internal input fuse	T10A H.B.C.	not user replaceable

*) In case of a protection event, audible noise may occur.

15. SAFETY FEATURES

Input / output separation *)	SELV PELV	IEC/EN 60950-1 IEC/EN 60204-1, EN 50178, IEC 62103, IEC 60364-4-41
Class of protection	III	PE (Protective Earth) connection not required. A connection of the "Chassis Ground" pin to earth is recommended for best EMI performance
Isolation resistance	> 5MΩ	input to output, 500Vdc
PE resistance	< 0.1Ω	between housing and Chassis Ground terminal
Touch current (leakage current)	The leakage current which is produced by the DC/DC converter itself depends on the input voltage ripple and need to be investigated in the final application. For a smooth DC input voltage, the produced leakage current is less than 100µA.	

*) Double or reinforced insulation

16. DIELECTRIC STRENGTH

The output voltage is floating and has no ohmic connection to the ground.

Type and factory tests are conducted by the manufacturer. Field tests may be conducted in the field using the appropriate test equipment which applies the voltage with a slow ramp (2s up and 2s down). Connect all phase-terminals together as well as all output poles before conducting the test. When testing, set the cut-off current settings to the value in the table below.

Fig. 16-1 Dielectric strength

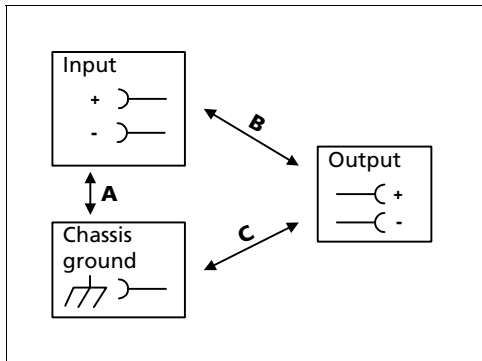

		A	B	C
Type test	60s	1500Vac	1500Vac	500Vac
Factory test	5s	1500Vac	1500Vac	500Vac
Field test	5s	1000Vac	1000Vac	500Vac
Cut-off current setting		> 30mA	> 30mA	> 12mA

To fulfill the PELV requirements according to EN60204-1 § 6.4.1, we recommend that either the + pole, the - pole or any other part of the output circuit shall be connected to the protective earth system. This helps to avoid situations in which a load starts unexpectedly or can not be switched off when unnoticed earth faults occur.

17. USED SUBSTANCES

The unit does not release any silicone and is suitable for the use in paint shops.

The unit conforms to the RoHS directive 2002/96/EC









Electrolytic capacitors included in this unit do not use electrolytes such as Quaternary Ammonium Salt Systems.

Plastic housings and other molded plastic materials are free of halogens, wires and cables are not PVC insulated.

The production material within our production does not include following toxic chemicals:

Polychlorized Biphenyl (PCB), Polychlorized Terphenyl (PCT), Pentachlorophenol (PCP), Polychlorinated naphthalene (PCN), Polybrom Biphenyl (PBB), Polybrom Biphenyl-oxyd (PBO), Polybrominated Diphenylether (PBDE), Polychlorinated Diphenylether (PCDE), Polydibromphenyl Oxyd (PBDO), Cadmium, Asbest, Mercury, Silicia

18. APPROVALS

IEC 60950-1		CB Scheme, Information Technology Equipment
IEC 61010-1		CB Scheme, Electrical Equipment for Measurement, Control and Laboratory Use
UL 508		LISTED for use in U.S.A. (UL 508) and Canada (C22.2 No. 107-1-01) E-File: E198865 Industrial Control Equipment
ANSI / ISA 12.12.01-2007		RECOGNIZED E327416 recognized for use in U.S.A. (ANSI / ISA 12.12.01-2007) and Canada (C22.2 No. 213-M1987) Hazardous Location Class I Div 2 T4 Groups A,B,C,D
UL 60950-1		RECOGNIZED for the use in U.S.A. (UL 60950-1) and Canada (C22.2 No. 60950-1) E-File: E137006 Information Technology Equipment, Level 3
NEC Class 2	NEC CLASS 2	According to NEC (National Electrical Code) Article 725-41 (4). Listed as Limited Power Source (LPS) in the UL 60950-1 UL report.
UL 61010-1		E-File: E326782 Electrical Equipment for Measurement, Control and Laboratory Use
ANSI / ISA 12.12.01-2007		RECOGNIZED E246877 recognized for use in U.S.A. (ANSI / ISA 12.12.01-2007) and Canada (C22.2 No. 213-M1987) Hazardous Location Class I Div 2 T4 Groups A,B,C,D The unit is suitable for use in Class I Division 2 Groups A, B, C, D locations. Substitution of components may impair suitability for Class I Division 2 environment. Do not disconnect equipment unless power has been switched off. Wiring must be in accordance with Class I, Division 2 wiring methods of the National Electrical Code, NFPA 70, and in accordance with other local or national codes.
ATEX	 II 3G Ex nAC II T4	Suitable for use in Class 1 Zone 2 Groups IIa, IIb and IIc locations. Number of ATEX certificate: EPS 08 ATEX 1 142 X. DC/DC converter must be built-in in an IP54 enclosure.

19. FULFILLED STANDARDS

EN 61558-2-17	Safety of Power Transformers
EN/IEC 60204-1	Safety of Electrical Equipment of Machines
EN/IEC 61131-2	Programmable Controllers
EN 50178, IEC 62103	Electronic Equipment in Power Installations